



Process Mass Spectrometry in Hydrocarbon Processing



Driving Plant Optimization at the Speed of Mass Spectrometry.

Field-Proven Technology with a Worldwide Installation Base

Fast, accurate, comprehensive gas analysis data enables model predictive control systems to be updated in real-time, resulting in production unit optimization and maximum profitability. Hydrocarbon processing plants around the world use Thermo Scientific process mass spectrometers to optimize a diverse range of chemical production processes as well as to monitor fugitive emissions. The new Thermo Scientific Prima PRO and Sentinel PRO mass spectrometers are built to meet the application-specific needs of today's modern integrated chemical production plant, ensuring enhanced operation of a number of manufacturing units (figure 1).

Figure 1: Hydrocarbon processing flow diagram indicating a sampling of manufacturing units that benefit most from process mass spectrometry

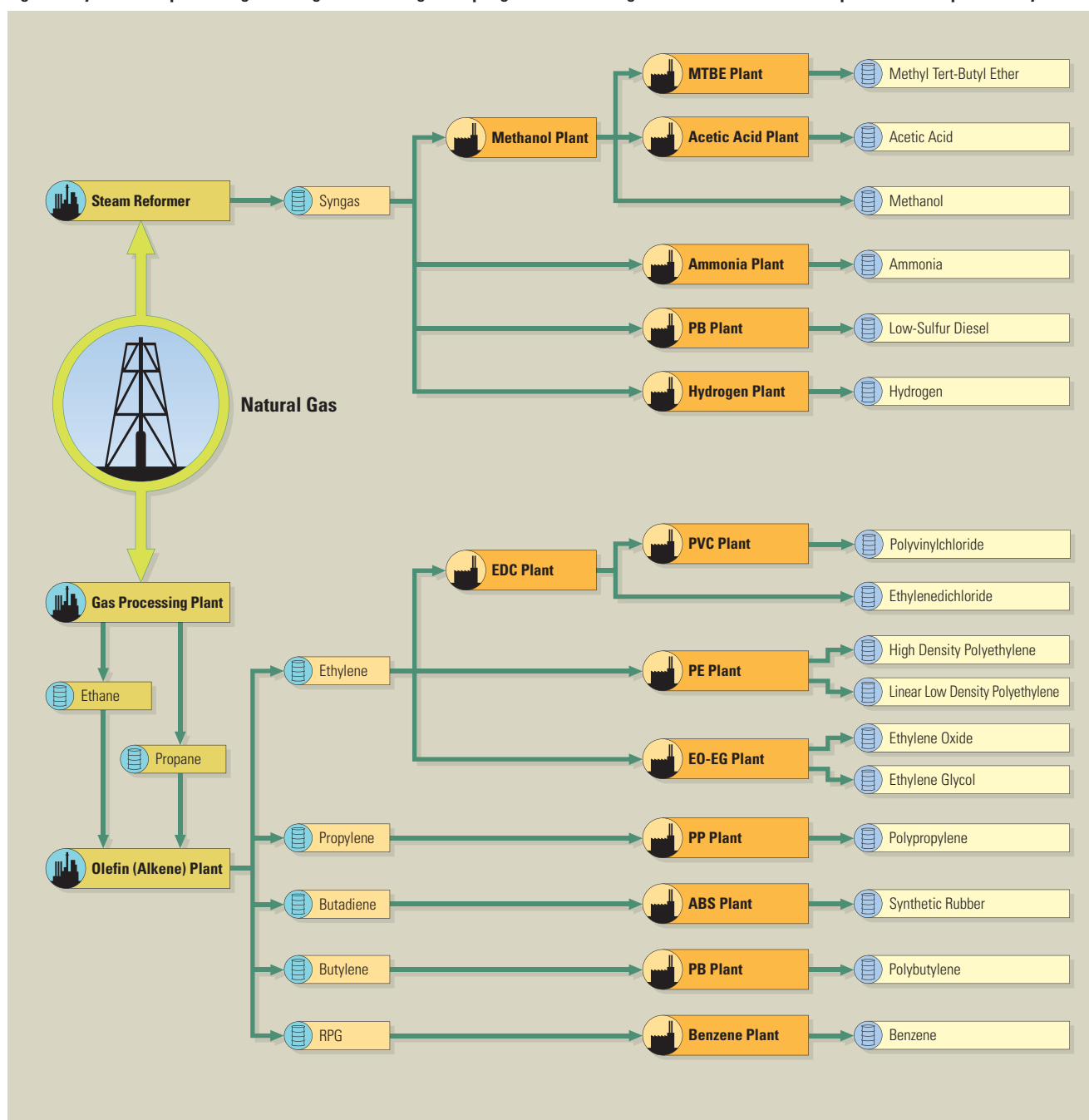

Thermo Scientific Prima PRO and Sentinel PRO: The Next Generation Begins

Backed by more than 30 years of process mass spectrometry success, the next-generation Thermo Scientific Prima PRO and Sentinel PRO have been engineered to meet a number of challenging hydrocarbon applications, including:

- Natural gas processing
- Olefin production
- Cracking furnace optimization
- Ethylene oxide / ethylene glycol
- Polyolefin production
- Ammonia production
- Fugitive emissions of toxic VOCs.

The Prima PRO process mass spectrometer (MS) increases yields via precise analysis of multiple gas process streams and has proven to deliver faster, more complete online gas composition analysis. Minimal maintenance requirements, ease-of-use and its ability to provide reliable, real-time data to the distributed control system (DCS) ensure a strong return on investment. Built on the same platform as the Prima PRO, the Sentinel PRO environmental mass spectrometer offers many of the same advantages yet is designed to fulfill the need for pinpoint environmental monitoring of fugitive emissions. It semi-continuously monitors 60 to 120 sample points and features highly sensitive detection capabilities to ensure reliable leak detection, increasing plant safety as well as regulatory compliance. In addition, a single Sentinel PRO or Prima PRO can easily replace multiple gas chromatograph (GC) systems to reduce sample time, simplify maintenance and, most importantly, lower overall capital costs.

Principles of Operation

The cornerstone of both the Prima PRO and the Sentinel PRO, and the preferred technology for highly stable, rapid gas analysis, is the scanning magnetic sector MS. Using this technology, gas is continuously drawn from the sample-conditioning system via a multi-stream inlet into the ion source where the gas molecules are ionized and fragmented. The ions are accelerated at high energy into the electromagnetic mass filter before selected ions are counted at the detector. The fragmented molecules produce a very repeatable 'fingerprint' spectrum, allowing gases with similar molecular weights to be measured with high accuracy and without interference. The onboard controller presents gas concentration data and derived values, such as calorific value and carbon balance, directly to the process control system using a variety of industry standard protocols. A rugged, fault-tolerant design ensures availability, typically exceeding 99.7%, while maintenance requirements are significantly minimized.



New Models Deliver Strong ROI

- Fast (1 to 20 seconds per point) online gas analysis for accurate tracking of process dynamics
- Comprehensive compositional gas analysis results in more data supplied to advanced process control (APC) models
- Stable with a 30 to 90 day calibration interval (automated)
- Reliable, fault-tolerant design for availability of >99.7%
- Small footprint with no large shelter required
- Minimal maintenance requirements reduce operating costs

A Single Prima PRO Does the Work of 10 Gas Chromatographs.

Natural Gas Processing

Raw inlet gas may originate from nearby gas fields or it may be a product of another type of process (i.e., refinery off-gas) or it may be collected as associated gas from oil fields. As a result, the composition and volume of each inlet stream to the gas plant may be significantly different. Generally, natural gas consists of 85% methane and varying amounts of natural gas liquids (NGL), including ethane (C₂H₆), propane (C₃H₈), normal butane (n-C₄H₁₀), isobutane (i-C₄H₁₀), pentanes and higher molecular weight hydrocarbons (C₅₊), inerts (typically nitrogen and helium), and acid gases, such as hydrogen sulfide (H₂S) and carbon dioxide (CO₂). The latter are removed in the Acid Gas Removal Unit using membrane technology or aqueous amine solutions. The sulfur

is recovered in the Sulfur Unit (or Claus Unit) which employs a two-step thermal and catalytic process to convert the H₂S into elemental sulfur. Tail gas is the common term for the remaining gas which is treated for residual H₂S and subsequently incinerated.

Water vapor, trace mercury and nitrogen are removed before the gas plant fractionates the raw gas into residue gas, ethane, propane, butane and natural gasoline products. The various stages of the fractionation train rely on boiling point differences to separate the individual paraffins.

Prima PRO: Rapid, Precise Compositional Gas Analysis

Using the Prima PRO, fast, online, highly accurate analysis of the properties of these process gases is achieved. The properties include complete and precise compositional analysis and the calculation of calorific value (gross and net), density, specific gravity, Wobbe Index, stoichiometric air requirement and the combustion air requirement index (CARI). The latter value is used for combustion control where gas is burned within the processing plant. The Prima PRO also provides precise gas composition as inputs to the material balance equations that are used to control the various stages of the process. Additional Prima PRO benefits include:

- Reduced energy consumption (fuel gas and electricity)
- Increased liquids recovery
- Precise measurement of the product's energy value
- Reduced environmental emissions.

Gas Component	% Molar Concentration	Precision % Absolute
CO ₂	6.000	0.005
CH ₄	84.849	0.010
N ₂	0.100	0.005
C ₂ H ₆	5.500	0.003
C ₃ H ₈	1.000	0.001
n-C ₄ H ₁₀	0.500	0.001
i-C ₄ H ₁₀	0.500	0.001
n-C ₅ H ₁₂	0.200	0.001
i-C ₅ H ₁₂	0.200	0.001
C ₆ H ₁₄	0.100	0.001
H ₂ S	0.001	0.00005

NOTE: Precision is the standard deviation observed over 24 hours and assumes an analysis time of 15 seconds.

Figure 2: Natural gas process flow diagram

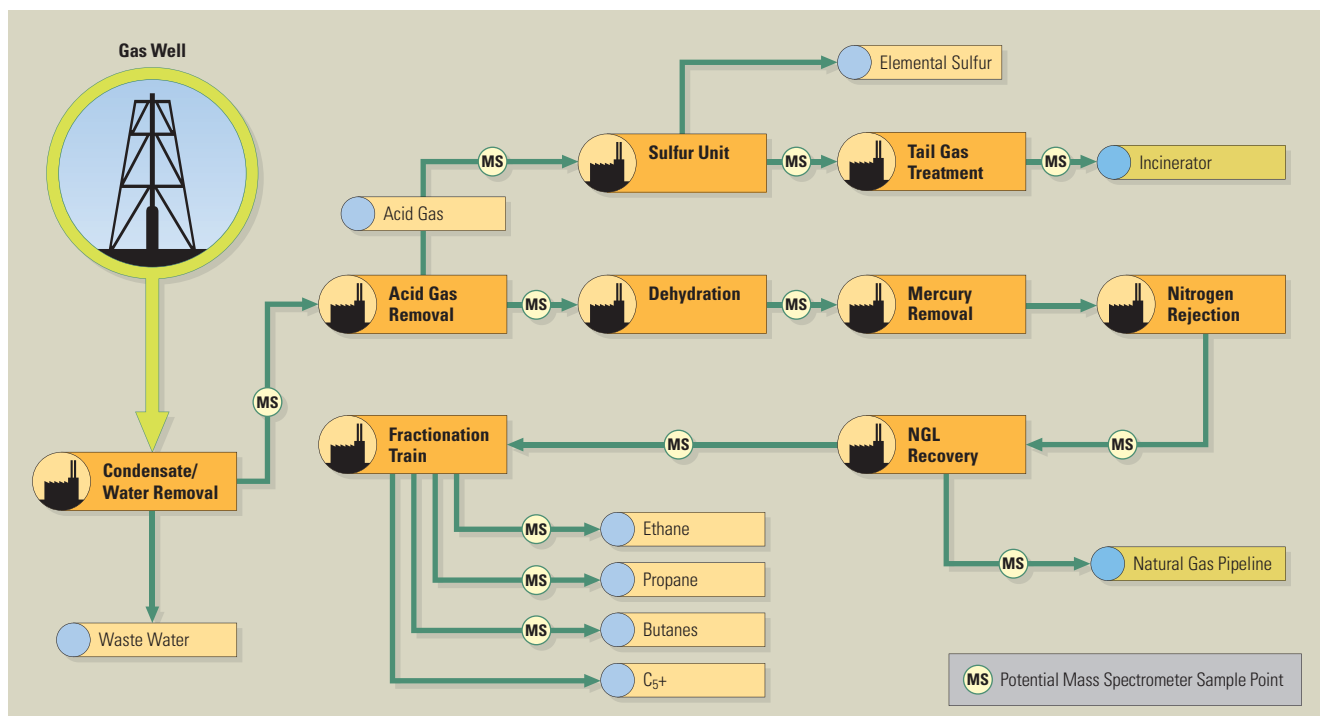

Olefin Production

A typical olefin plant is divided into two basic sections: cracking furnaces and the fractionation train. Ethylene cracking, or pyrolysis, furnaces break down saturated hydrocarbons into smaller, unsaturated hydrocarbons. The principal industrial method for producing lighter alkenes, or olefins, including ethylene, propylene and butylene, is steam cracking. In this process, a gaseous or liquid hydrocarbon feed (i.e. naphtha, LPG, hydrocracked vacuum gas oils or a simple ethane/propane mix) is diluted with steam and briefly heated in a furnace. The reaction temperature is typically very high (~850°C) with reaction time limited to less than a second. In modern cracking furnaces, the residence time is reduced to milliseconds, resulting in ultrasonic gas velocities, to improve the yield of desired products. After the cracking temperature has been reached, the gas is quickly quenched in a transfer line heat exchanger to stop the reaction. The product yield during the reaction depends on the composition of the feed, the hydrocarbon-to-steam ratio, the cracking temperature and the furnace residence time.

Light hydrocarbon feeds, including ethane, LPGs or light naphthas, yield product slates rich in lighter alkenes, including ethylene, propylene, and butadiene. Naphthas and refinery liquid feeds produce some of these lighter alkenes, but also yield products rich in aromatic hydrocarbons that

are suitable for pyrolysis gasoline or fuel oil. The higher cracking temperature, or severity, favors the production of ethylene and benzene, whereas lower severity produces relatively higher amounts of propylene, C4-hydrocarbons and liquid products.

This process also results in the slow deposition of coke on the furnace tube or cracking coil walls. In turn, the efficiency of the reactor degrades since the carbon layer limits heat transfer and increases pressure drop. Reaction conditions are designed to minimize the coke deposition rate. Kinetic models are used to predict the thickness of the coke layer, ensuring the effect on cracking severity versus furnace temperature can be predicted. A steam cracking furnace can usually only run for a few months at a time between de-coking which requires the furnace be isolated from the fractionation train. A flow of steam or a steam/air mixture is passed through the furnace coils, resulting in the conversion of the hard solid carbon layer to carbon monoxide and carbon dioxide. Once this reaction is complete, the furnace can be returned to service. Alternatively, an off-line, low temperature mechanical method using a caustic wash to blast the carbon deposits out of the coils is effective. Either way, each furnace is down for at least 27 hours during the de-coking process. The following section describes how cracking furnace optimization is achieved using the Prima PRO.

Figure 3: Cracking furnace

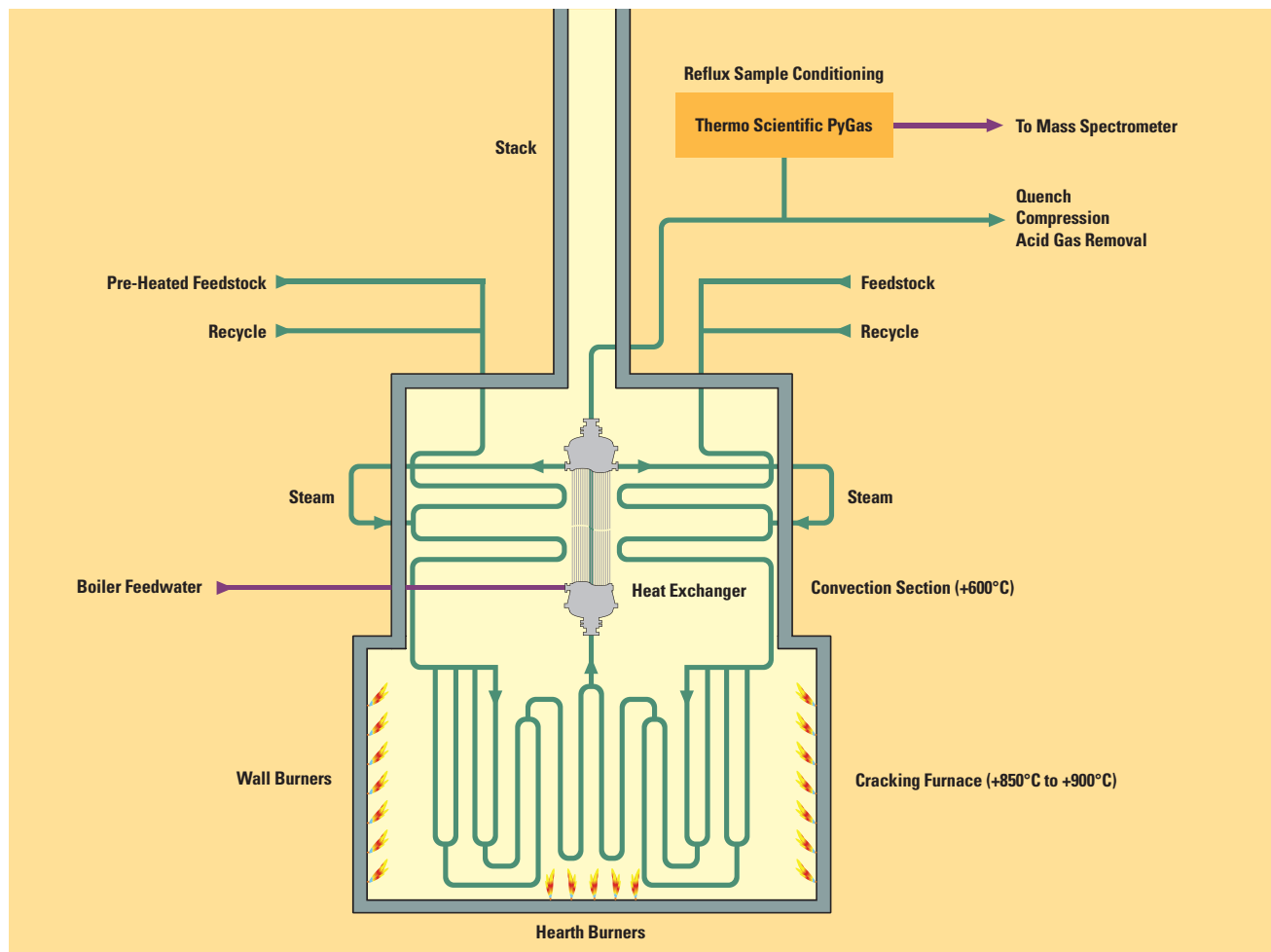

Increase Yield Without Sacrificing Ease-of-Use or Simple Maintenance.

Cracking Furnace Optimization Basic Principles

At any given moment, product yields depend on many factors, including feedstock composition, dilution steam flow, hydrocarbon flow, coil temperature distribution (i.e. the burner firing rate and fuel energy content), furnace draft and cracking coil coke composition. Model predictive control (MPC) is used to predict some of these variations based on numerous measured parameters, such as the coil outlet temperature and feed flow rates. Subsequently, the temperature and residence time can be optimized to maximize the yield of the target olefins while minimizing the coke deposition rate. Although the relationships between the numerous process variables are complex, it is generally true that, if the cracking severity is too low, the ethylene yield will be low. If the cracking severity is too high, the coking rate will be high and the yield degradation will be unacceptable.

Cracking Severity Technology Comparison

Figure 4a illustrates how the actual cracking severity may vary over time when the dynamic models are operating with no compositional feedback. In these situations, a typical ethylene yield will be approximately 62% for a gas-fed unit.

Figure 4b illustrates the beneficial effect of using online gas chromatographs (GC) to measure the actual cracking severity index (i.e., propylene/ethylene and propylene/methane ratios). This regular six-minute interval measurement facilitates tighter control allowing the severity set point to be raised. This upgrade will typically provide a 5% increase in yield on a gas-fed cracker, explaining why the majority of the world's ethylene units employ process GCs for process control purposes.

Figure 4c illustrates how tighter control can be achieved when the GCs are replaced by the Prima PRO in a more modern facility. The speed

of the Prima PRO allows a single process MS to replace five GCs while reducing the sample interval from six minutes to two, resulting in an additional 2% increase in yield.

It should be noted that the GC analysis is restricted to a C₁ to C₃ analysis because speed is important for this very dynamic process. Whereas this measurement is sufficient for measuring the actual cracking severity index, it does not provide sufficient data to allow the kinetic models to accurately predict the coke deposition rate which results from the agglomeration and polymerization of heavy hydrocarbons. Therefore, in a typical installation, additional GCs will be provided for a much slower extended C₁ to C₄ analysis to provide additional data for the models. The analysis is further extended for liquid-fed furnaces since C₅ analysis is required to calculate the Kinetic Severity Factor (KSF) which is used to optimize the production of specific olefins depending on market conditions (Table 2). Additional extended-analysis GCs will typically be multiplexed to allow a single GC to monitor four to five furnaces. A single Prima PRO, however, monitors the complete composition of the furnace effluent with no additional units required.

The extended analysis of the Prima PRO also provides the additional capability of monitoring the heavy hydrocarbons that would normally be removed by the Thermo Scientific PyGas reflux sample conditioning system. This data provides predictive maintenance capabilities in the event that breakthrough occurs in the sample conditioning system, ensuring more reliable operation.

Table 2: Target kinetic severity factors

KSF	Product to be Maximized
1.7	Propylene
2.3	Butadiene
2.7	Combined Olefins
3.9	Ethylene

Figure 5: Ethylene concentration by GC and MS

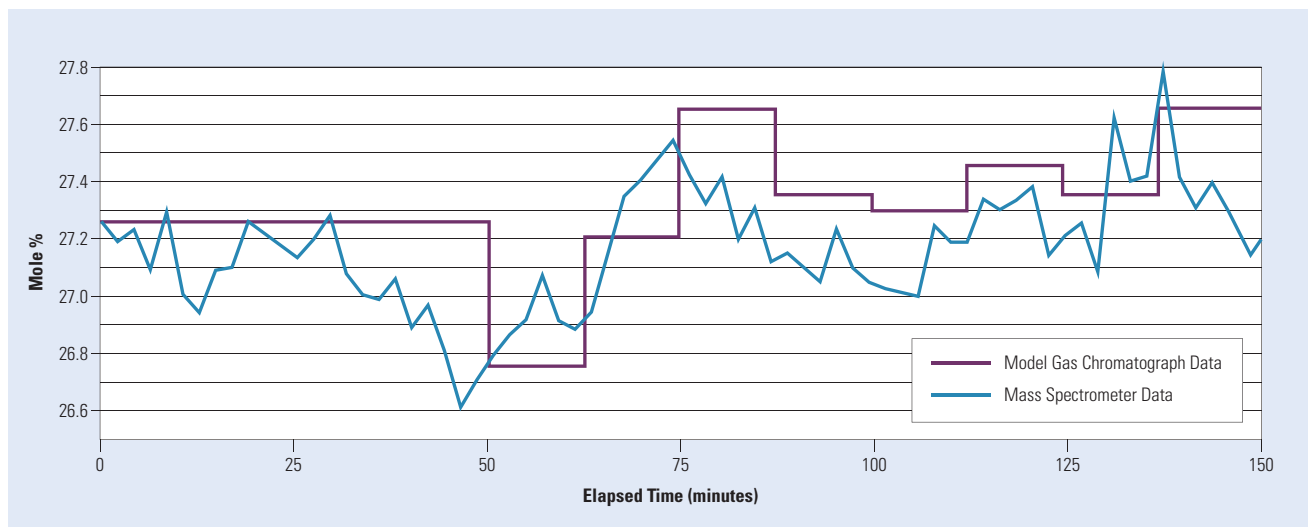

Cracking Severity Results

Figure 4a: No online analysis

Variations caused by changes in feedstock and gas velocity

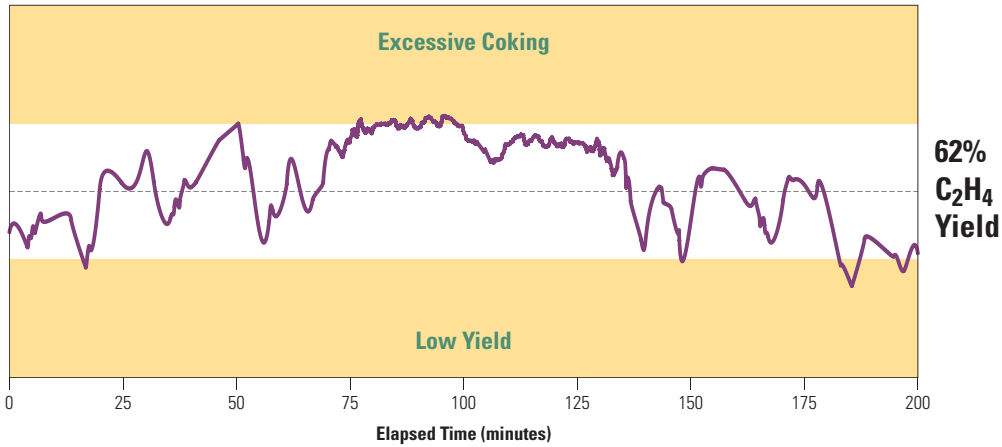

Figure 4b: Reset using GC

One gas chromatograph per furnace measuring C_1-C_3 every six minutes

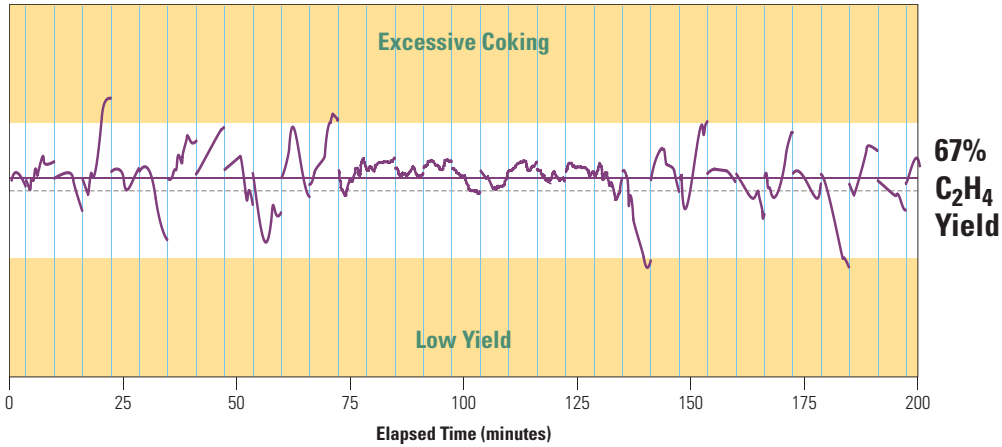
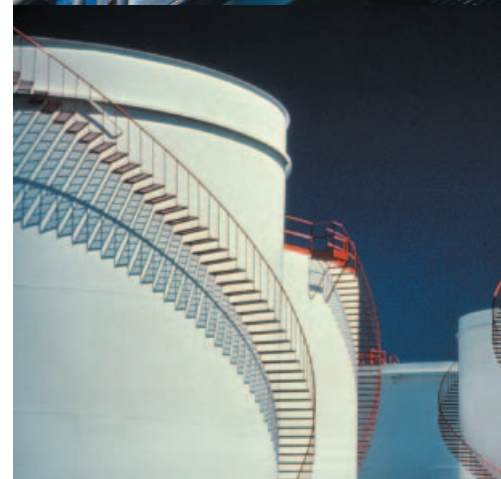
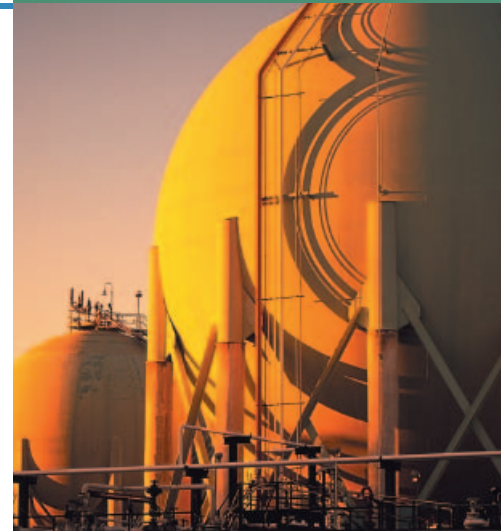

Figure 4c: Reset using MS

One mass spectrometer per five furnaces measuring C_1-C_{7+} every two minutes



Superior Analytical Performance at One Third of the Cost.

Cost/Benefit Analysis for Cracking Severity Control

Prima PRO Solution

Figure 6 illustrates a Prima PRO configured with 60 sample ports and 24 calibration ports. A redundant pair of similarly configured MSs can replace the 15 GCs as illustrated in Figure 7 at approximately 33% of the capital cost while providing superior analytical performance. In addition, the two Prima PROs can be installed in a relatively inexpensive shelter at roughly 25% of the GC shelter price. The maintenance cost is also much less at approximately 20% of that for the GC-based solution. While the calibration gas consumption will be higher for the Prima PRO, the costs associated with this gas are minimal when compared to the initial outlay and ongoing cost of maintaining the GCs. In addition, the Prima PRO does not require hydrogen fuel or helium carrier gas, making it an even more economical solution.

Process GC Solution

Figure 7 illustrates a typical configuration with 10 GCs deployed for cracking severity control with an additional five extended analysis chromatographs providing data for the APC kinetic models. The capital cost for the GCs is approximately \$1 million. In addition, maintenance for these systems must be carried out in all types of weather. While some GCs are able to fully compensate for climatic influences and can be located outdoors without a large, expensive shelter, some GCs cannot. A pre-fabricated shelter will house complete pre-piped and pre-wired, assembled systems. In addition, all necessary utilities and communications can be pre-installed. While this scenario provides the perfect environment for maintenance personnel, the disadvantage is the high cost associated with a large shelter. With a large number of GCs to maintain, the total cost of ownership is high: approximately \$7,000 per GC per annum, excluding carrier, fuel and calibration gas consumption.

Figure 6: Mass spectrometer with 60 sample and 24 calibration ports



Figure 7: Typical GC configuration for a 10-furnace ethylene unit

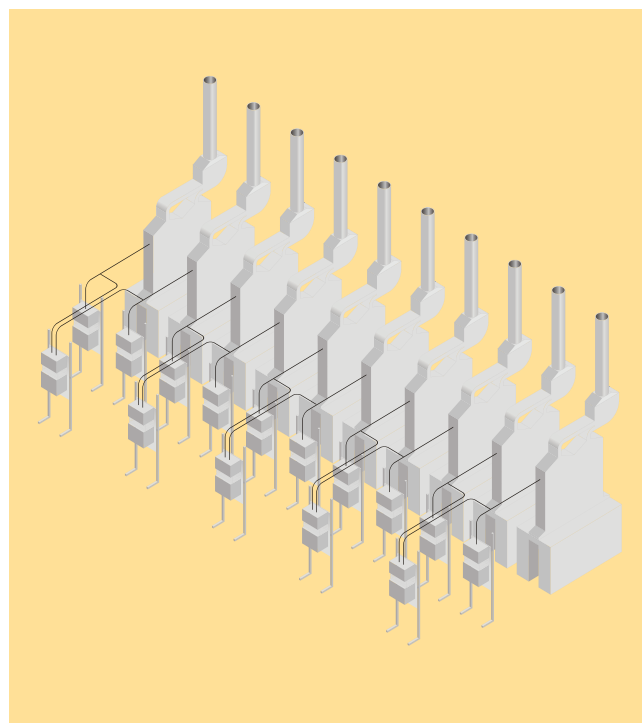

Ethylene Oxide / Ethylene Glycol

Ethylene oxide (EO) is manufactured by the direct oxidation of ethylene over a silver oxide catalyst. Because the EO molecule is highly reactive, production is often integrated with ethylene glycol which is easily transported. Ethylene, compressed oxygen and the recycle gas are preheated before being injected into one of the tubular reactors that contains the silver oxide catalyst. Selectivity, as in the production of the target molecule rather than CO_2 and H_2O , is improved by the addition of chlorine compounds. Catalyst activity declines over time, requiring a gradual increase in reaction temperature. To increase the flammable limit in the reactor, methane is added.

Prima PRO: The Optimal Gas Analysis Solution

The Prima PRO enables optimization of the gas analysis process by accurately measuring selectivity and by measuring the molecular balances of carbon and oxygen to validate accuracy. The data collected is often used to control chloride additions. The Prima PRO is also the preferred technology for catalyst development research, where the goal is to increase the efficiency of the catalyst at high rates of activity.

Table 3: Typical EO/EG performance specification

Gas Component	Molar Concentration	Precision % Absolute
CH_4	45.50 %	0.03
N_2	2.00 %	0.03
C_2H_4	25.00 %	0.02
C_2H_6	1.00 %	0.005
O_2	5.00 %	0.005
Ar	10.00 %	0.01
EO	1.50 %	0.005
CO_2	10.00 %	0.008
Methyl Chloride	3.00 ppm	0.20
Vinyl Chloride	3.00 ppm	0.20
Ethyl Chloride	3.00 ppm	0.20
Allyl Chloride	3.00 ppm	0.20

NOTE: Precision is the standard deviation observed over 24 hours and assumes an analysis time of 15 seconds.

Figure 8: Schematic drawing of a typical ethylene oxide unit

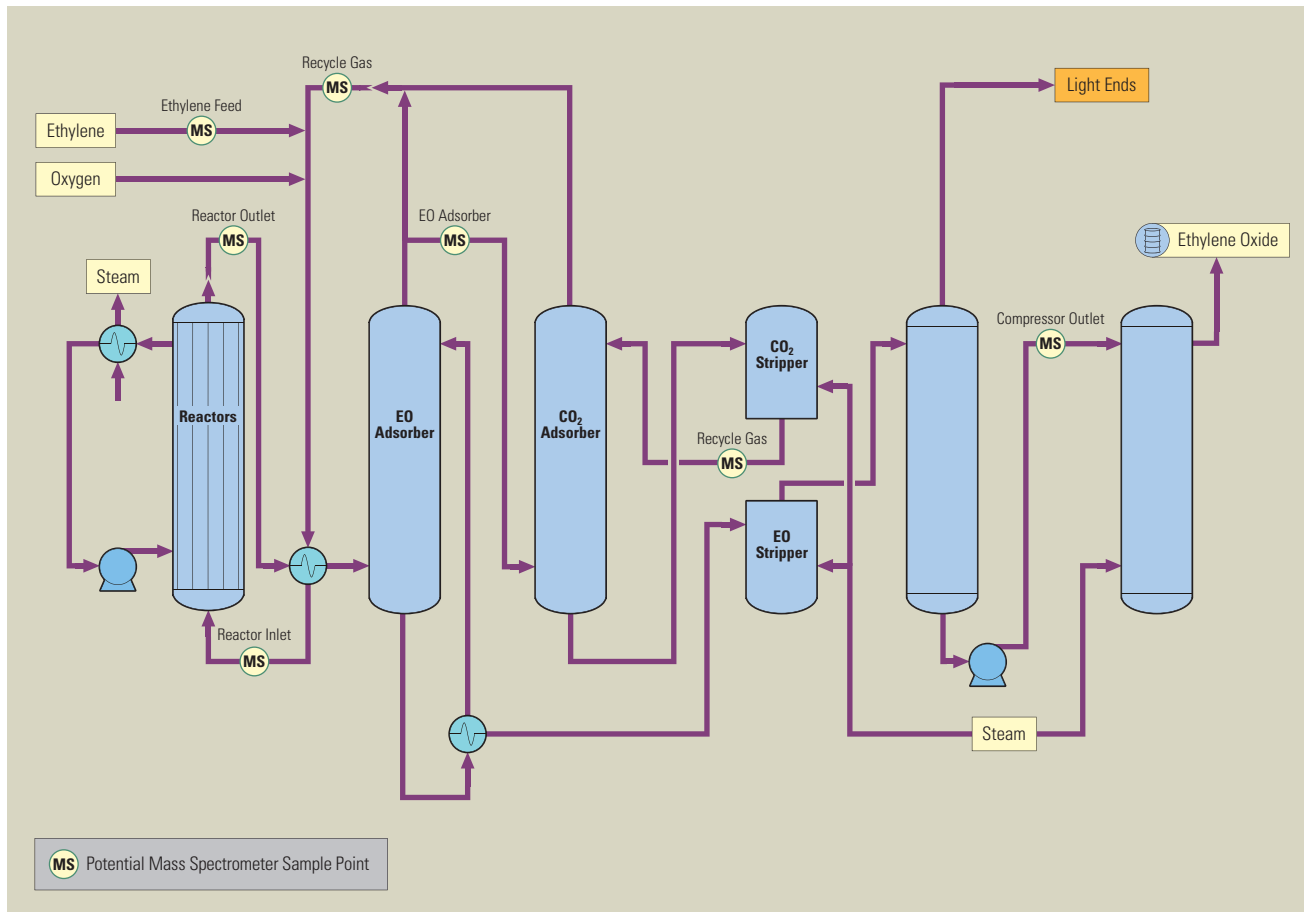

Raise the Bar on Product Quality.

Figure 9: High-density polyethylene (HDPE) and linear, low-density polyethylene (LLDPE)

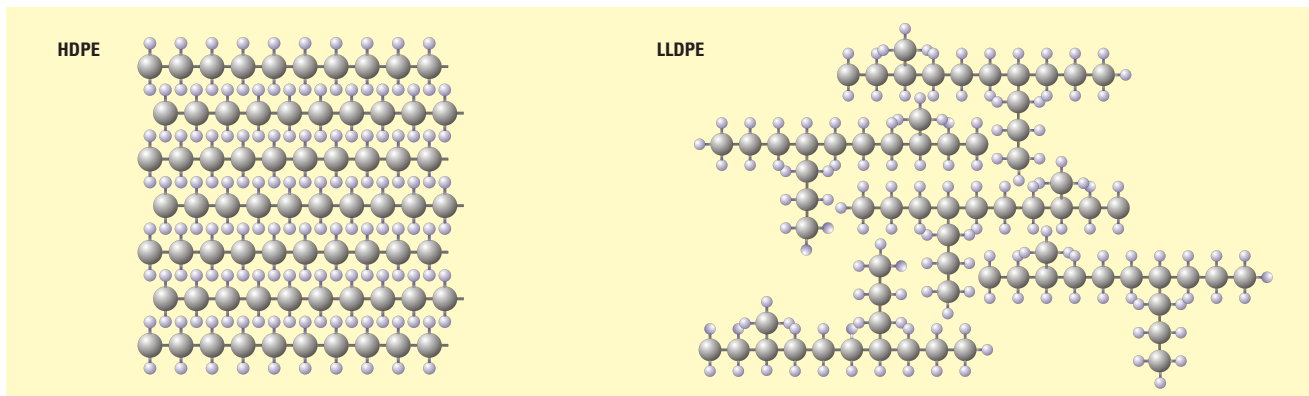

Polyolefin Production

Polyethylene (PE) is classified into several different categories based mostly on its density and branching. The mechanical properties of PE depend significantly on variables, including the extent and type of branching, the crystal structure and the molecular weight. HDPE has a low degree of branching and thus stronger intermolecular forces and tensile strength. The lack of branching is ensured by an appropriate choice of catalyst and reaction conditions. LLDPE is a substantially linear polymer with significant numbers of short branches, commonly made by co-polymerization of ethylene with short-chain alpha-olefins (i.e., 1-butene, 1-hexene and 1-octene). A full range of polymers can be manufactured using a swing process that employs one or two fluidized bed gas phase reactors. These polymerization reactors are fed with ethylene, hydrogen, co-monomers and recycle gases. Polymer quality is controlled through gas composition which requires accurate and rapid online analysis.

Prima PRO: Precision, Speed and Multi-Stream Monitoring

Figure 10 illustrates the data generated during an experiment. A Prima PRO, configured to monitor five process streams, was compared with GC data compiled for monitoring the gas composition of the reactor feed. The Prima PRO clearly tracks the variation in the hydrogen/ethylene ratio with greater precision than the GC. Also, the Prima PRO updates the DCS nine times faster than the single-stream GC, even as the Prima PRO is measuring five streams. During the first 40 PMS data points, the DCS is attempting to control the ratio using the GC data. When control is switched to the Prima PRO data, the variation of the ratio is substantially improved with several benefits resulting, including:

- More consistent product quality
- Tighter molecular weight distribution
- Less off-spec product
- Improved steady-state kinetics.

Figure 10: Process Gas Chromatography and Process Mass Spectrometry control comparison

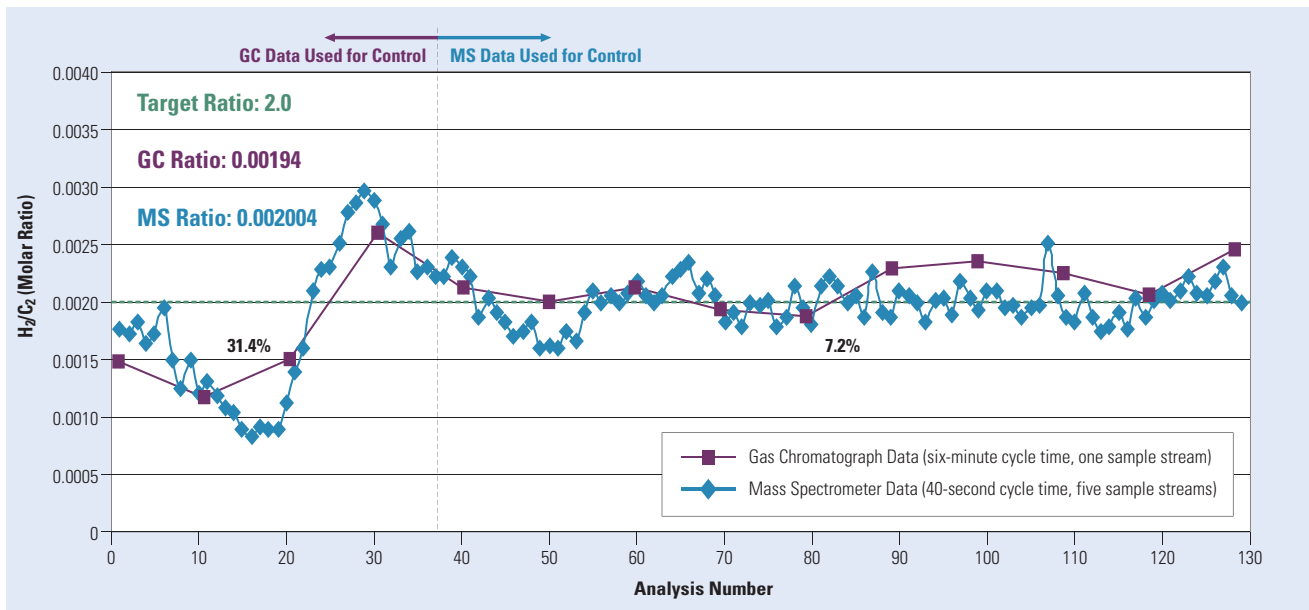

Ammonia Production

Sulfur is removed from the hydrocarbon feed stream and subsequently mixed with steam over a nickel-based catalyst in order to produce hydrogen and CO. Elemental carbon formation is minimized to protect the catalyst by maintaining the steam-to-carbon ratio above 3:1. Unreacted methane, referred to as slippage, also needs to be controlled at a low level in order to optimize the reformer performance. At the secondary reformer, air is introduced at a controlled rate in order to produce a 3:1 hydrogen/nitrogen ratio. Oxygen from the air oxidizes most of the CO into CO₂ while steam is added to convert the remaining CO into CO₂ and hydrogen. The bulk of the CO₂ is removed in the absorber and the trace amounts of carbon are converted catalytically into methane. The converter feed gas is mixed with recycled gas and the H:N ratio is again tightly controlled at the converter inlet in order to maximize the conversion efficiency into NH₃. The buildup of inert gases (i.e., argon and helium) that are included in the air feed needs to be monitored since the gases can become a significant dilutant if not periodically purged.

Prima PRO: Stable, Reliable Online Gas Analysis

- Best available accuracy for feed gas composition and calculated heating value; reduces energy consumption due to the tight control of the steam-to-carbon ratio ($\pm 0.01\%$)
- Tight control of the hydrogen/nitrogen ratio ($\pm 0.003\%$) maximizes product yield
- Accurate measurement of methane slippage lowers production costs
- High sample rate (10 to 12 streams in under two minutes) can result in a 1 to 2% increase in product yield when compared to the control provided by slower GCs or less stable MSs
- Extremely low total cost of ownership
- Rapid payback

Figure 11: Ammonia synthesis flow diagram

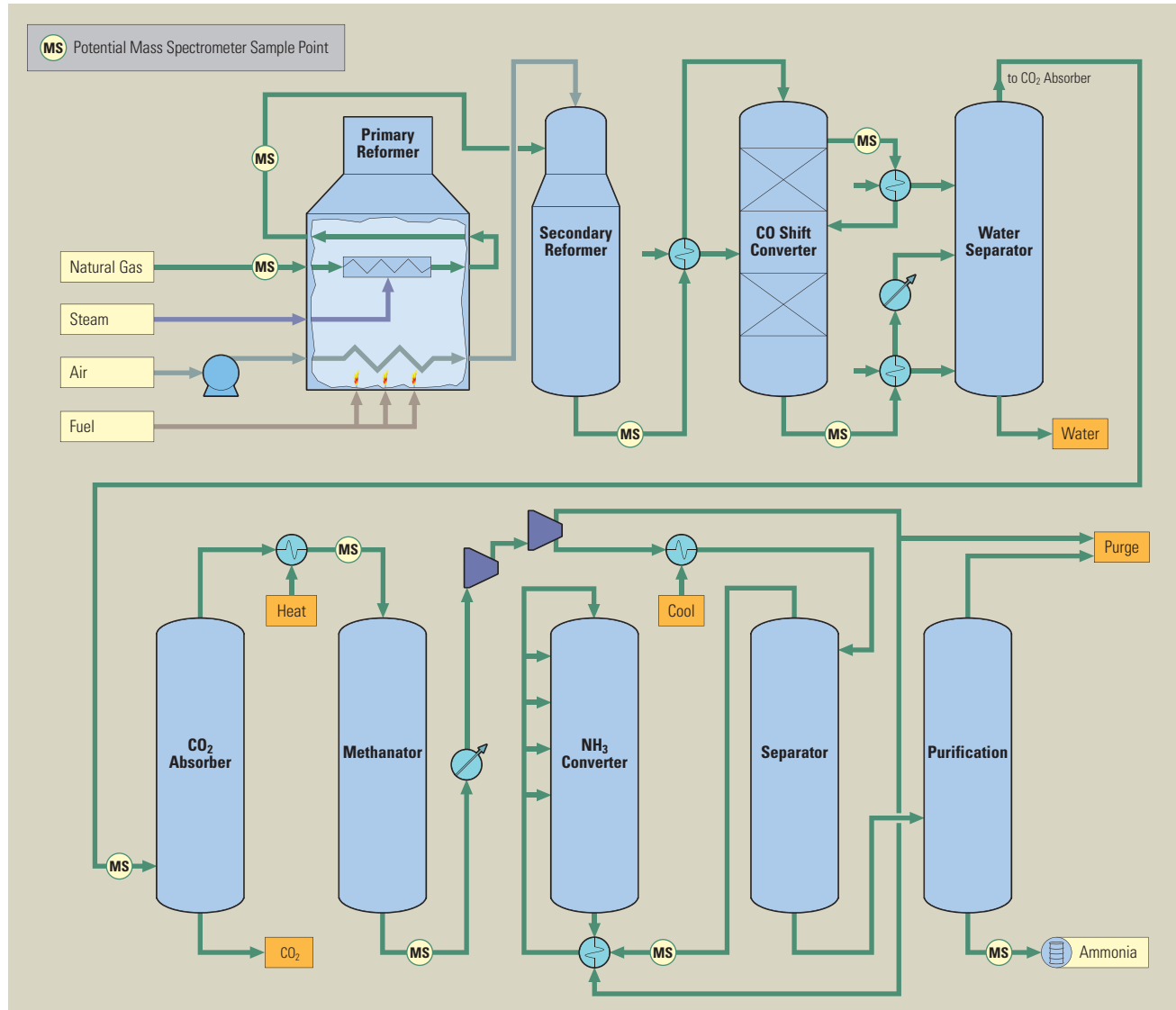

Ensure Plant Safety and Increase Productivity.

Fugitive Emissions of Toxic VOCs

Wherever there is potential danger for fugitive emissions of toxic organic vapors from a chemical production unit, regulating authorities often require plants to keep records of ambient vapor concentrations to protect workers from long-term exposure. Various forms of capture include evacuated vessels (Summa canisters), organic vapor monitors, or purge and trap devices. Captured samples then need to be sent to an environmental laboratory for analysis. Alternatively, electrochemical sensors can be used to immediately indicate the presence of a target molecule at a concentration that exceeds a pre-determined level. One quantitative alternative is to use open path FT-IR spectroscopy for measuring the presence of specific VOCs along a fence line. The data provided by these various technologies is often all that is needed to meet local regulations. However, none of these technologies are capable of providing the spacial and temporal resolution required to qualify as actionable information.

Sentinel PRO: Simple, Comprehensive Data Collection

The Sentinel PRO environmental mass spectrometer is capable of monitoring 100 or more sample points, within 15 minutes, with species-specific detection in the 0.01 to 1 ppm range. With speed and precision, it monitors all the critical areas for short-term exposure levels as well as provides accurate eight-hour, time-weighted, average exposure data. With a high number of available sample points, many can be located close to potential leak points, such as valve stems, etc., enabling leak detection and correction before any toxic hazard is created. Although personnel protection and environmental compliance are the primary drivers for this type of installation, the result is often times a more leak-tight and efficient chemical production unit.

Figure 12: Sample selection and enrichment

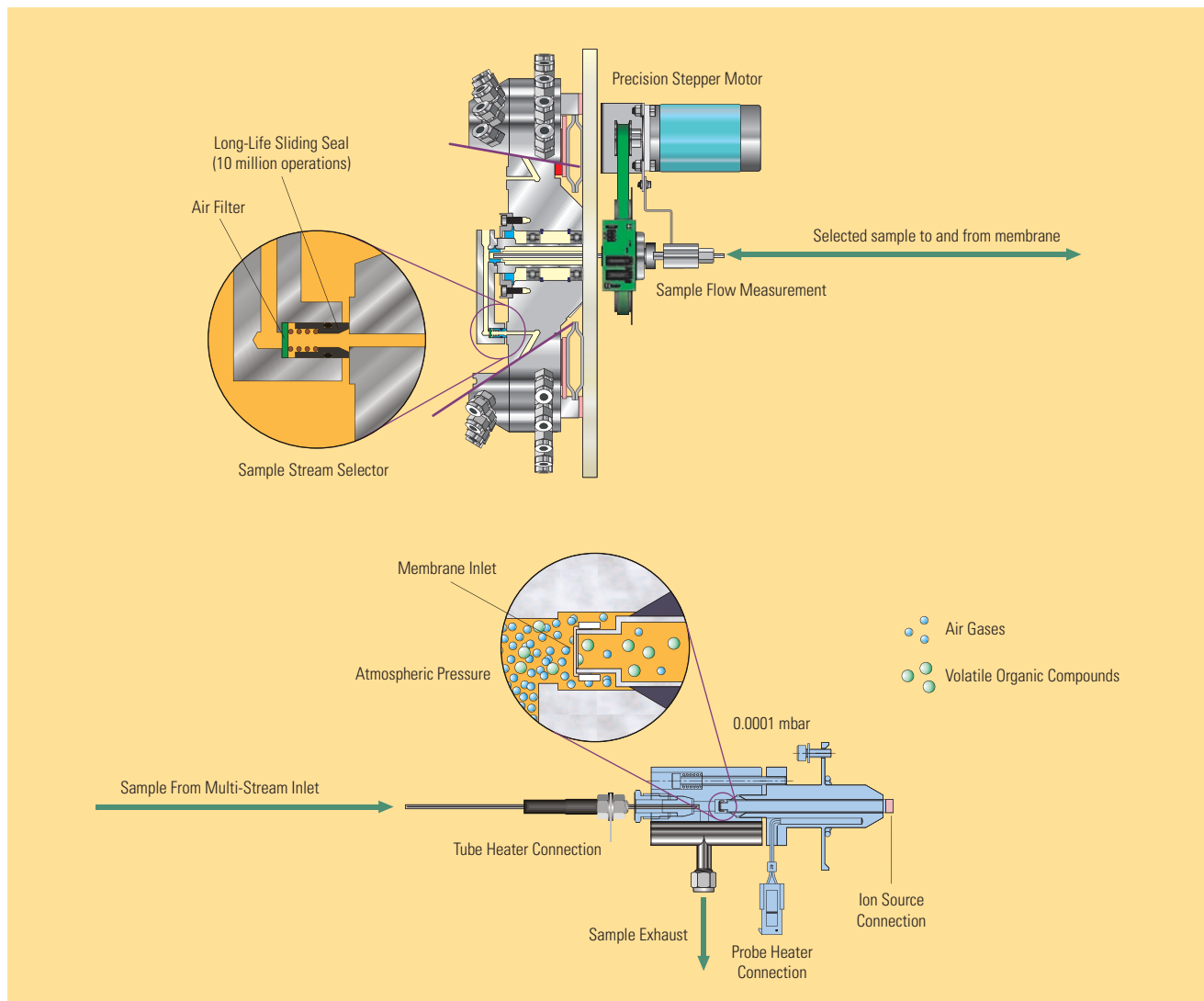



Sentinel PRO: Membrane Inlet Mass Spectrometry

A key to the success of the Sentinel PRO is the unique rapid multi-stream sampler (RMS), available with 32 or 64 ports. It features a zero dead-volume design that allows fast flushing with zero crossover effects. Each Sentinel PRO can be fitted with two RMS assemblies, allowing a single system to replace a whole rack of less sensitive, discrete detectors. The RMS includes a sample bypass design that permits a single flow detector to monitor each of the streams in turn. If a filter becomes plugged or liquid blocks a sample tube, a system alarm sounds. The analyzer is fitted with a membrane inlet to reduce the pressure of the sample air from atmospheric to the working pressure of the Sentinel PRO's enclosed ion source (typically 10^{-4} mbar). This membrane inlet system allows a method of sample introduction that greatly enhances the system's sensitivity to volatile organic compounds (VOC). For the majority of VOCs, sub ppm detection limits are routinely achieved, ensuring the Sentinel PRO will accommodate future changes in legislation. Since the membrane is more permeable to VOCs than to major air gases, it can often provide enrichment by several orders of magnitude, including a benzene detection limit of <0.01 ppm. The Sentinel PRO's heated inlet probe assembly provides a stable, representative sample for introduction into the ion source. In addition, the ergonomic design of the probe permits easy membrane replacement during annual routine maintenance to minimize downtime and increase productivity.

Thermo Scientific Sentinel PRO



Sentinel PRO: Species-Specific Detection from 0.01 ppm to 1 ppm

Acetone
Acetonitrile
Acrylonitrile
Benzene
Butadiene
Carbon Disulphide
Carbon Tetrachloride
Chloroform
Chlorobenzene
Cyclohexane
Dichloromethane
Dimethylacetemide (DMAC)
Dimethyl Formamide (DMF)
1,4-Dioxane
Epichlorohydrin
Ethyl Benzene
Ethylene Oxide
Freons
Hexamethyldisilazane
Hydrogen Cyanide
Methyl Bromide
Methyl Ethyl Ketone
Methyl Iodide
Methyl Isobutyl Ketone
Methyl Methacrylate
1-Methyl-2-Pyrrolidinone
Methyl Tertiary-Butyl Ether (MTBE)
Propylene Oxide
Propan-2-ol
Perchloroethylene
Styrene
Tetrahydrofuran
Tetrachloroethylene
Toluene
Trichloroethylene
Vinyl Acetate
Vinyl Bromide
Vinyl Chloride
Xylene

Optimize Plant Productivity.

Thermo Scientific GasWorks Software

The Thermo Scientific GasWorks software suite provides an intuitive, information-rich and flexible window into the operation of the Prima PRO and Sentinel PRO. Produced in a certified ISO 9001 environment, GasWorks software is designed for rapid installation and to facilitate ongoing operation while providing a secure, stable platform for process analytics. It is simple to configure, operate and maintain without the need for specialist mass spectrometry knowledge.

The suite includes a wide range of functions and features, allowing it to be matched exactly to the needs of the user. Whether the requirement is for simple alarm indication in the event of a manufacturing process failure, or for complex data presentation for process understanding and control, GasWorks is well equipped to offer an effective solution. Regular updates ensure that the software takes advantage of the latest technology as it becomes available.

Figure 13: GasWorks software sample display

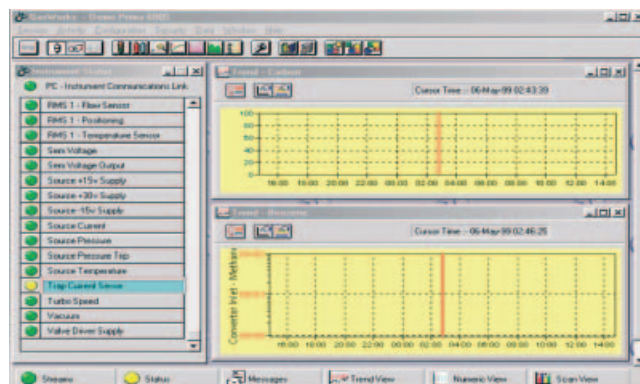

World-Class Service & Support

Our service and support options are designed to ensure instrument optimization and reduce downtime. Because every customer and every instrument has different requirements, we offer a variety of services to meet your unique needs, including:

- Service agreements
- Spare parts
- Technical support
- Field installation and service
- Product training.

Optimizing Plant Processes in Real Time

We manufacture a wide range of process instrumentation designed to meet the application-specific needs of the hydrocarbon industry, including:

- Process mass spectrometers
- Online gas analyzers
- Ultrasonic and turbine liquid flowmeters
- Gas and liquid density meters
- Nuclear density and level gauges.

Our solutions have proven to enhance operational efficiency, ensure optimal product quality, maximize product yield and provide an ongoing return on investment.



Process Mass Spectrometry in Hydrocarbon Processing

© 2010 Thermo Fisher Scientific Inc. All rights reserved. Results may vary under different operating conditions. Specifications, terms and pricing are subject to change. Not all products are available in all countries. Please consult your local sales representative for details. Literature Code: PI.2077.0410

14 Gormley Industrial Avenue, Unit 14 Gormley, Ontario L0H 1G0 CANADA	+1 (905) 888-8808 +1 (905) 888-8828 fax
Unit 702-715, 7/F Tower West Yonghe Plaza No. 28, Andingmen East Street Beijing 100007 CHINA	+86 (10) 8419-3588 +86 (10) 8419-3580 fax
A-101, ICC Trade Tower, Senapati Bapat Road Pune 411016 Maharashtra INDIA	+91 (20) 6626 7000 +91 (20) 6626 7001 fax
Ion Path, Road Three, Winsford Cheshire CW7 3GA UNITED KINGDOM	+44 (0) 1606 548700 +44 (0) 1606 548711 fax
1410 Gillingham Lane Sugar Land, TX 77478 USA	+1 (800) 437-7979 +1 (713) 272-0404 +1 (713) 272-4573 fax

Process Instruments

www.thermoscientific.com/prima

Thermo
SCIENTIFIC